

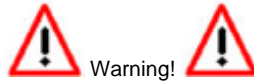

MTX-L Digital Air/Fuel Ratio Gauge User Manual



The Oxygen Sensor used in this device gets very hot in operation. Do not touch a hot sensor. Do not let a hot sensor touch a combustible surface. Do not use the sensor with or near flammable liquids or gases. Failure to heed these warnings may result in severe burns, explosions, fires, or other dangerous events.

When installed in the exhaust, the oxygen sensor MUST be connected and operating with the MTX-L whenever the car is running. An un-powered oxygen sensor can be quickly damaged when exposed to hot exhaust gases.

TABLE OF CONTENTS

1	MTX-L.....	3
2	Installation	4
2.1	Wiring	4
2.1.1	Single Innovate Device Relay Wiring Instructions.....	5
2.2	Mounting and Routing	5
2.3	Sensor Placement	6
2.4	Sensor Calibration.....	7
2.4.1	Calibration Schedule.....	8
2.5	Changing the MTX-L's gauge face and/or bezel.....	8
3	Download the Logworks 3 software package	8
3.1	Installing software.....	9
3.2	Connecting to LM Programmer	9
3.2.1	Analog Outputs	9
3.2.2	Advanced output programming	11
3.2.3	Updating the Firmware	11
3.3	Logging data from your MTX-L with LogWorks.....	12
3.4	Customizing your fuel type	12
3.5	Customizing your display range	13
4	Wiring Analog Outputs	14
	Appendix A: Limited Warranty.....	15
	Appendix B: MTX-L Error Codes and Troubleshooting Tips.....	16

1 MTX-L

The MTX-L is an integrated gauge and controller for wideband AFR (lambda) measurements. Although it can be operated stand alone, it has digital I/O for integration with other MTS compatible products and two configurable analog outputs for integration with ECU's and 3rd party data loggers. The following views will help you get familiar with the unit.

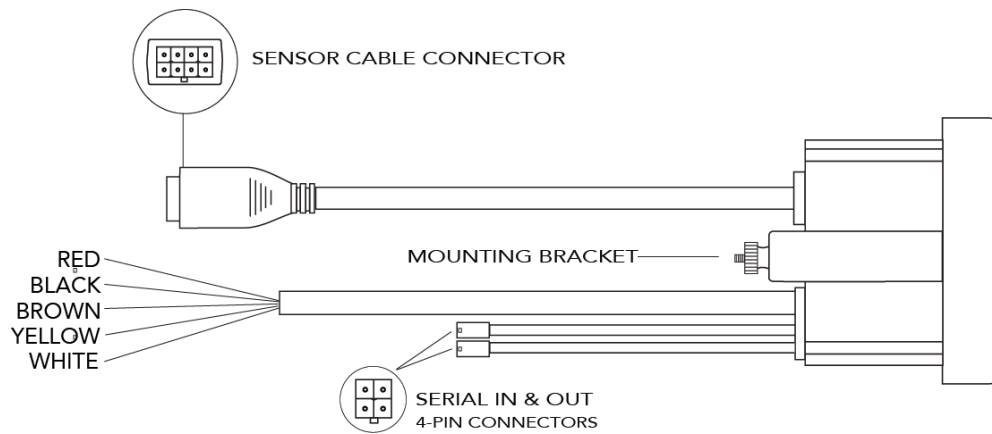
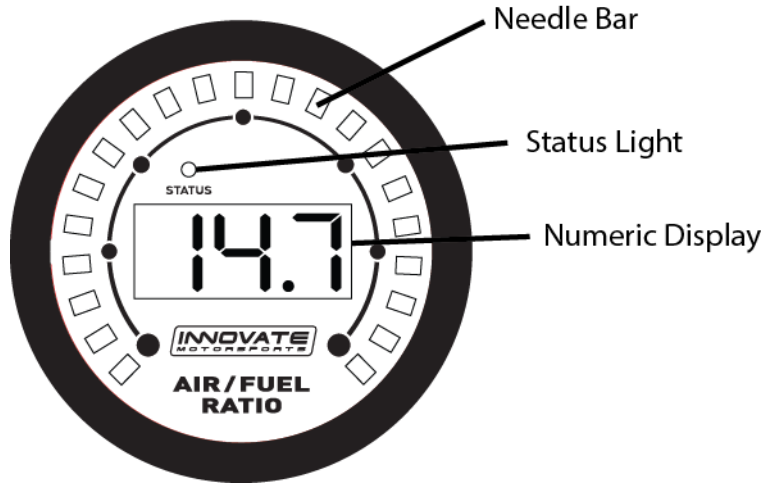

2 Installation

2.1 Wiring

The MTX-L has 5 stripped wire ends:

- 1 Connect the **RED** wire to an isolated switched 12V source in your vehicle. A switched 12V source goes ON as soon as “key on” power is active. The circuit to which you will pull power from should be able to support a 3 amp draw. Make sure this connection is protected with a 5A fuse.



Circuits that share power with the vehicle’s stereo, ignition system, ECU, lighting, or fuel pump should not be used. When in doubt, create an additional circuit using an automotive relay available at any automotive parts supplier. See the next section for a relay installation diagram.

- 2 The **BLACK** wire should be grounded to a solid ground source. The best possible ground source would be the battery ground (-) post.



If other Innovate Motorsports devices are going to be daisy-chained along with the MTX-L, it is recommended that all devices be connected to a single ground point, ideally the battery ground (-) post.

- 3 Connect the **WHITE** wire to a headlight power wire (a wire that supplies current to the headlights). This enables the display to dim for better nighttime viewing. **DO NOT CONNECT THIS WIRE TO THE HEADLIGHT DIMMING WIRE.** Connection to this rheostat type of switch will cause the gauge to malfunction. If you chose not to utilize the dimming feature, connect the **WHITE** wire to ground.
- 4 *Optionally*, the **YELLOW** (Analog out 1) and/or **BROWN** (Analog out 2) can be connected to the analog inputs of other devices such as data loggers or ECUs. If either one or both of these wires are not being used isolate and tape the wire(s) out of the way. The default analog outputs are as follows: Analog output one (yellow) is 0V = 7.35 AFR and 5V = 22.39 AFR. Analog output two (brown) is 1.1V = 14 AFR and .1V = 15 AFR.

2.1.1 Single Innovate Device Relay Wiring Instructions

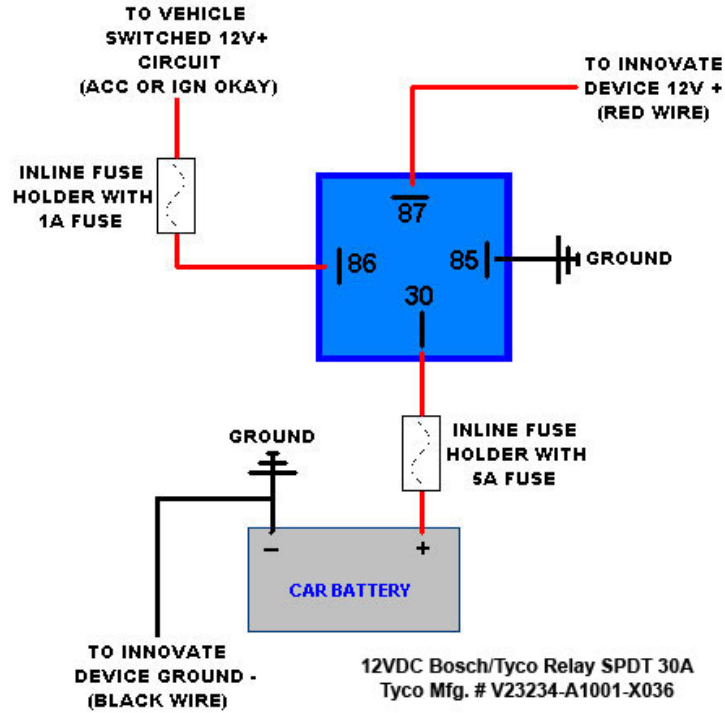

2.2 Mounting and Routing

The MTX-L gauge fits in any standard 2 1/16" (52mm) gauge pod. Mounting of the gauge should be done in such a manner that the cables are not being forcefully pulled and strained from the gauge itself. Route the sensor cable avoiding contact with the exhaust pipe and other hot sources that could melt the cable. Also avoid routing the sensor cable near ignition components or other sources of RF (radio frequency) and EMI (Electromagnetic interference) noise.



The MTX-L gauge is splash resistant (not water proof) and can be mounted so that it is exposed to the outdoor elements. The MTX-L should not be submerged and special consideration should be taken to protect the gauge from direct water spray (water coming from a pressurized source.) When replacing the bezel and/or gauge face verify that the o-ring is properly seated.

2.3 Sensor Placement

Optimum bung placement will vary from application to application, but using the guideline below will ensure the longest sensor life with the most accurate readings. Using a bung is the preferred method for mounting the oxygen sensor in all applications.

- Weld the bung at least **24 inches downstream** of the exhaust port outlet (after the collector), or 24 inches after the turbocharger if so equipped. The bung should be welded before the X or H pipe if so equipped.
- Using a clock as reference, mount the bung between the **9:00 o'clock and 3:00 o'clock position**. Welding the bung in the lower section of the exhaust pipe can result in sensor damage caused by condensation making contact with the sensor's internal heating element.
- A **1" bung** (provided in the kit) will best protect the sensor. When fully threaded, the sensor's tip will sit flush with the exhaust pipe, this does **not** adversely effect the readings.
- The bung should always be welded before the Catalytic Converter. Welding the bung after the catalytic converter will skew the readings toward lean. The skew in readings will vary with engine load and the efficiency of the catalytic converter.
- Leaded fuel and two stroke applications will reduce the sensor's life. There are many other factors that dictate the sensor's lifespan so it is impossible to predict it's total longevity.
- Exhaust leaks, camshaft overlap, and open (shorty) exhausts will cause false lean readings at light engine loads. Typically, once the engine is under load and the exhaust gas volume increases, you will see accurate readings.
- When installed in the exhaust, the oxygen sensor must be connected to a powered, functional MTX-L (no error codes) whenever the engine is running. An un-powered sensor will be damaged in a short period of time when exposed to exhaust gas.
- Do not pre-warm the sensor before starting the engine, simply start the engine as normal. Allowing the sensor to pre-warm before starting the engine will increase the possibility of damaging the sensor from shock-cooling.

- The maximum temperature of the sensor at the bung (the sensor mounting location) should not exceed 500 °C or 900 °F. If these temperatures are exceeded in your application you should install the Innovate Motorsports HBX-1 heat sink bung extender. (p/n 3729.)

2.4 Sensor Calibration

Once the unit has been wired and a suitable location has been found for both the gauge and the sensor it is time to do the sensor calibration. Innovate Motorsports' 'Direct Digital' wideband measurement principal allows you to calibrate the sensor to compensate for sensor wear. This procedure takes just a few moments and it will ensure the most accurate readings throughout the oxygen sensor's life. This procedure is required anytime a NEW oxygen sensor is installed.

The calibration procedure requires that the oxygen sensor be in **free air**, this means removed from the exhaust system completely.

1. With the **sensor disconnected**, apply power to the MTX-L.

When power is applied, all three digits will light up and the needle bar will sweep once through all LEDs. Then the status light will turn red and the numeric display will read "E2". This is an error code, indicating that no sensor is detected. Leave unit powered on for minimum 30 seconds.

2. **Power down** the MTX-L and attach the oxygen sensor using the cable provided. When making these connections, make sure they are fully seated and locked. Again, make sure that the sensor is in free air (not in the exhaust).

3. **Power up** the MTX-L.

Again, the display should 'sweep', but instead of an error, the display will display "Htr". This indicates that the sensor is being heated up to operating temperature. After 30-60 seconds, the display will switch from "Htr" to "CAL", indicating that the sensor is being calibrated. A few seconds later, your MTX-L will begin displaying AFR. Since the sensor is in free air, the gauge will default to the upper limit of 22.4.

The calibration procedure has completed and the system is now ready for use.

Important: You can disconnect and reconnect the sensor and sensor cable for installation without losing your calibration. However, if you power up the MTX-L without a sensor connected, **your calibration will be reset** (see step #1 above).

2.4.1 Calibration Schedule

Normally aspirated (daily driver)

- Calibrate before installation of new sensor
- Calibrate new sensor again after 3 month of use
- Thereafter calibrate once a year or every 20,000 miles, whichever comes first

Turbo Application, daily driver (tuned rich)

- Calibrate before installation of new sensor
- Calibrate new sensor again after 3 month of use
- Thereafter calibrate twice a year or every 10,000 miles, whichever comes first

Race Application

- Calibrate before first installation of new sensor
- Calibrate once per race weekend

2.5 *Changing the MTX-L's gauge face and/or bezel*

1. Lay the MTX-L face down and remove the three #2 phillips screws from the outside rim of the back plate.
2. Carefully lift out the bezel from the gauge cup.
3. Configure the gauge as desired by changing the gauge face and or bezel.

***Be sure to remove protective film from the gauge face. This can be done easily with a piece of scotch tape.**

4. Make sure every piece is positioned correctly using the locating tab and reassemble the gauge.
5. Reinstall the 3 #2 phillips screws.

3 Download the Logworks 3 software package

1. Open your web browser and go to:
<http://www.innovatemotorsports.com/support.php>
2. The LogWorks 3 software download will be the very first thing on the page, click the link to download the software.

3.1 **Installing software**

1. Double click on the Logworks 3 installer previously downloaded.
2. The installer will start, follow the prompts to install the software.

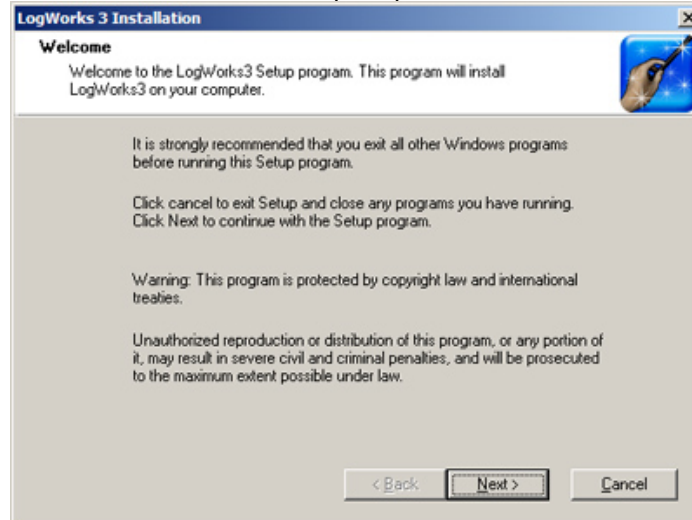

3. Once the software has been installed the LogWorks software, LM Programmer and MTX-L manual can then be located by navigating through Start->Programs->LogWorks3.

3.2 **Connecting to LM Programmer**

LM Programmer is used to update firmware, change fuel types, and program the two analog outputs.

1. Connect the OUT port of the MTX-L to the provided serial programming cable. Connect the other end of the serial programming cable to your computer. If your computer does not have a serial port, you can purchase a USB to Serial adapter from Innovate Motorsports (P/N 3733) or use any USB to serial adaptor that includes drivers. Make sure that nothing is connected to the IN port of the MTX-L
2. Power up the MTX-L.
3. Launch LM Programmer. The LM Programmer application can be launched from *Start->Programs->LogWorks3->LM Programmer* from the Windows task bar.

3.2.1 **Analog Outputs**

1. Connect the MTX-L to the computer and launch LM Programmer.
2. Select one of the Analog output tabs. The Analog output tab looks like this:

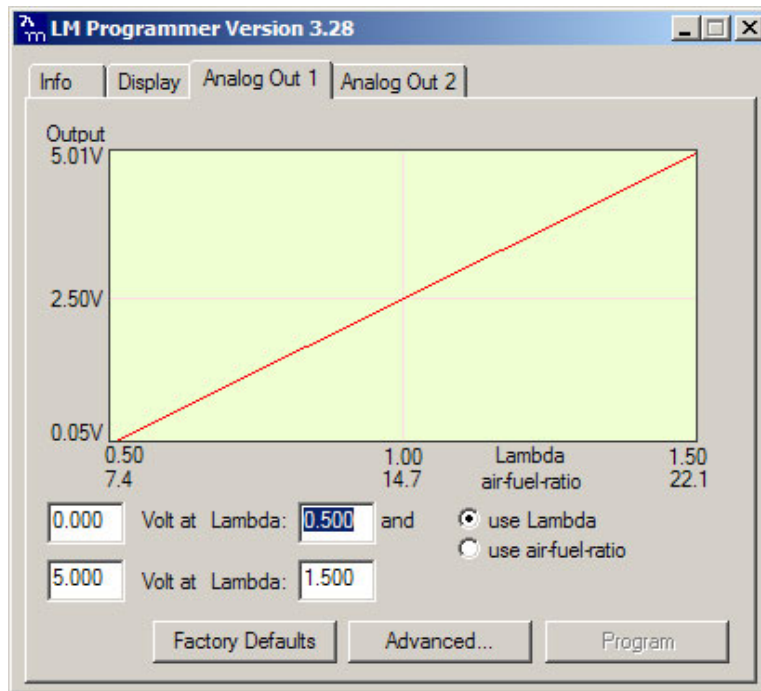

This shows the analog output voltages versus Lambda for one of the two analog outputs. The graph display is automatically scaled to the selected voltages. For each output you can specify a minimum and maximum lambda or A/F ratio value and the associated voltages. Below the minimum and above the maximum values the output voltages stay constant at the associated programmed voltage.

By selecting the 'use Air-Fuel-Ratio' button you can program the curve by AFR instead of Lambda. This does not change the programming, only the unit of measure displayed. When programming by AFR the LM Programmer converts the number to Lambda before programming the MTX-L. So there might be some small 'rounding errors' when you open LM Programmer and review your settings in the future.

Click the 'Program' button to upload the new programming data into the MTX-L. Once the unit is programmed the 'Program' button will grey out.

The analog outputs can be programmed from 0 to 5 volts and from 0.5 to 1.5 Lambda or 7.35 AFR to 22.39 AFR.

Factory Programmed Defaults:

Analog Output 1 is programmed to output between 0 V for an AFR of 7.35 (gasoline) and 5.0V for an AFR of 22.39. Analog Output 2 is 1.1 V for an AFR

of 14 and .1 V for an AFR of 15. Other settings, of course, are easily programmable between the minimum and maximum range specified earlier.



Avoid connecting or disconnecting any of the ports labeled IN or OUT while the unit is powered ON.

3.2.2 Advanced output programming

The 'Advanced' button allows the user to set the analog out update speed and the voltage output during sensor Warm-up and Error Condition. The factory defaults of the analog outputs update 1/12 of a second. The default voltage output is set at 0 volts for both the Warm-up and Error Condition.

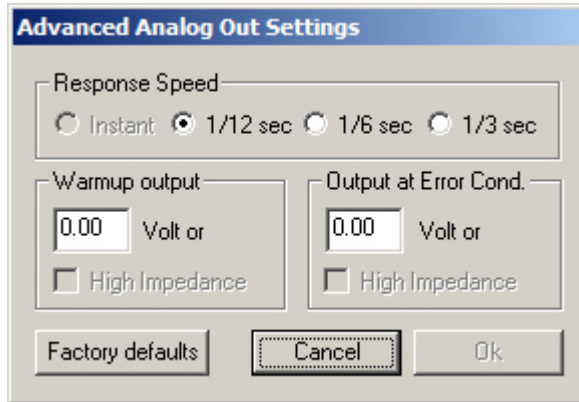

When setting the MTX-L to the slower response speed settings the measured mixture data will be averaged over the response time setting before being sent via the analog output.

3.2.3 Updating the Firmware



Do not update the firmware if the versions are the same. A firmware update should only be necessary if there has been a new release that specifically fixes a problem that you are experiencing with the controller.

1. Connect the MTX-L to the computer and launch LM Programmer.
2. Once connected, LM Programmer will display the current version of the firmware that is installed in the MTX-L. Do not update the firmware if the versions are the same. A firmware update should only be necessary if there has been a new release.

3. On the very first tab of LM Programmer you will see a button labeled "Update Firmware," click this button.
4. Select the firmware file with the dld extension. If there have been revisions to the firmware, you will find them available for download from the Support section of the Innovate Motorsports web site.
5. The software will now prompt you to confirm that you wish to overwrite the firmware currently on your MTX-L.
6. Click OK, DO NOT power off or disconnect the MTX-L from the computer until the firmware progress screen completely disappears. Once finished, you may disconnect the unit from the computer and exit out of the software.

3.3 Logging data from your MTX-L with LogWorks

1. Connect the OUT port of the MTX-L to the provided serial programming cable. Connect the other end of the serial programming cable to your computer. If your computer does not have a serial port, you can purchase a USB to Serial adapter from Innovate Motorsports (P/N 3733) or use any USB to serial adaptor that includes drivers. Make sure that nothing is connected to the IN port of the MTX-L. Power up the MTX-L
2. Launch LogWorks. The LogWorks application can be launched from *Start->Programs->LogWorks3->Logworks3* from the Windows task bar.
3. Once LogWorks launches go to *File->Connect*. You will be prompted to connect to the serial COM port. Select the comport the device is connected to and then click Connect.
4. To start recording go to *File->New Realtime Log* or, in the Toolbar, click on the  Tool.

3.4 Customizing your fuel type

The MTX-L gauge comes pre-programmed to display AFR in the gasoline scale. By connecting the gauge to LM Programmer, fuel type settings for different fuels can be setup. This setting can be found on the lower right hand corner of the Info tab in LM Programmer.



3.5 Customizing your display range

The MTX-L gauge can be setup to display different ranges from both the Needle Bar and the Numeric Display. There is also an option to display lambda or AFR. Lastly, the gauge can be setup to display percentage of Oxygen once the readings go beyond 7 lambda.

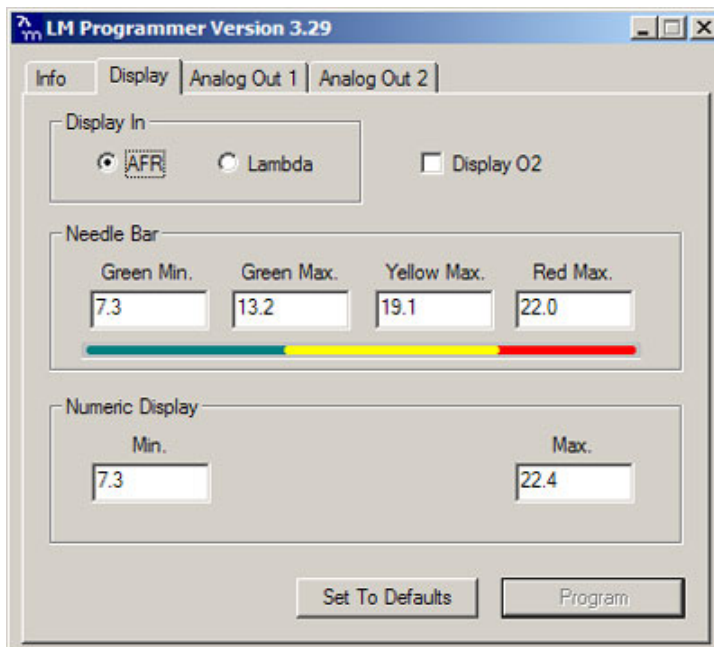

4 Wiring Analog Outputs

The analog outputs on the MTX-L are 'single ended'. That is, each output uses just one wire. It is assumed that the MTX-L and the device it is being connected to are already sharing the same 'ground'. In a vehicle, this is generally true, but there can be small offsets in voltage when devices are grounded to, say, the chassis at different points. You can minimize these offsets by sharing a good, common ground point, or you can adjust for them by configuring the analog output voltages on the MTX-L.

Appendix A: Limited Warranty

LIMITED WARRANTY

Innovate stands behind the quality of its products. Innovate makes the following warranty to purchasers of its products: All new Innovate products carry a one year warranty from the date of purchase. If proof of purchase cannot be provided, warranty will be determined by date of manufacture.

When Warranty Void

This warranty shall terminate and Innovate shall have no obligation pursuant to it if (i) your Innovate product has been modified or repaired in a manner not previously authorized by Innovate in writing, (ii) the identification markings on your Innovate product have been removed, defaced, or altered; (iii) your Innovate product was subjected to accident, abuse, shipping damage, or improper use; (iv) your Innovate product was not used or configured as specified in the product manual; or (v) your Innovate product was subjected to operating conditions more severe than those specified in the product manual.

Exclusions From This Warranty

Oxygen Sensors are excluded from this warranty.

Repairs Under This Warranty

In the unlikely event that your Innovate hardware product should prove defective during the warranty period, contact Innovate Customer Support at www.innovatemotorsports.com for a return material authorization (RMA). Products returned for service must be securely packed to prevent damage and shipped charges pre paid, along with proof of purchase and the return material authorization number, to the Innovate repair location as instructed by Customer Service. Innovate within a reasonable amount of time from its receipt of your product so shipped, will ship to you, at its option, the repaired product or a new or reconditioned product of comparable or greater specified functionality. All repaired or replacement products shall be warranted for the remainder of the original product warranty.

Disclaimer

INNOVATE MAKES NO OTHER EXPRESS OR IMPLIED WARRANTY WITH RESPECT TO YOUR INNOVATE PRODUCT OTHER THAN THE LIMITED WARRANTY SET FORTH ABOVE. No Innovate dealer, agent, or employee is authorized to make any modification, extension, or addition to this warranty, unless enforceable or unlawful under applicable law, INNOVATE DISCLAIMS ALL IMPLIED WARRANTIES, INCLUDING THE IMPLIED WARRANTIES OF MERCHANTABILITY, NONINFRINGEMENT, AND FITNESS FOR A PARTICULAR PURPOSE, AND THE LIABILITY OF INNOVATE, IF ANY, FOR DAMAGES RELATING TO ANY ALLEGEDLY DEFECTIVE PRODUCT SHALL UNDER ANY TORT, CONTRACT, OR OTHER LEGAL THEORY BE LIMITED TO THE ACTUAL PRICE PAID FOR SUCH PRODUCT AND SHALL IN NO EVENT INCLUDE INCIDENTAL, CONSEQUENTIAL, SPECIAL, OR INDIRECT DAMAGES OF ANY KIND EVEN IF INNOVATE IS AWARE OF THE POSSIBILITY OF SUCH DAMAGES. Some states do not allow limitations on how long an implied warranty lasts or the exclusion or limitation of incidental or consequential damages, so the above limitations or exclusions may not apply to you.

Appendix B: MTX-L Error Codes and Troubleshooting Tips

Error Code	Error Message	Likely Root Cause	Fix
Error 1	Heater circuit shorted	Short in sensor	Replace sensor.
Error 2	Heater circuit open	1. Damaged sensor cable or sensor. 2. Sensor connector not fully seated and locked into position.	1. Verify that all sensor connectors are fully seated and locked into position. 2. Replace sensor 3. Replace sensor cable.
Error 3	Pump cell circuit shorted	1. Short in sensor cable 2. Short in sensor 3. Sensor calibration incorrect	1. Replace sensor cable. 2. Replace sensor. 3. Perform sensor recalibration.
Error 4	Pump cell circuit open	1. Damaged sensor cable or sensor. 2. Connectors not fully seated 3. Sensor calibration incorrect	1. Verify that all sensor connectors are fully seated and locked into position. 2. Perform sensor calibration 3. Replace sensor cable. 4. Replace sensor.
Error 5	Reference cell circuit shorted	1. Short in sensor cable 2. Short in sensor	1. Replace sensor cable. 2. Replace sensor.
Error 6	Reference cell circuit open	1. Damaged sensor cable or sensor. 2. Connectors not fully seated	1. Verify that all sensor connectors are fully seated and locked into position. 2. Replace sensor. 3. Replace sensor cable.
Error 7	System error	System error	Reboot MTX-L by cycling power.
Error 8	Sensor Timing error (typically a damaged sensor).	1. Sensor over-heating or over-cooling (error condition only occurs at wide open throttle) 2. Sensor is damaged	1. Perform sensor calibration. 2. Move sensor bung as far downstream as possible. 3. Add an HBX-1 (p/n 3729) to isolate the sensor from the pipe. 4. Replace sensor.
Error 9	Supply Voltage too low	Supply voltage too low for sensor regulation	1. Verify you have 12V at your power source and the circuit can support a 3 amp draw.